

# Assembly instruction

## Universal swivel FORD

### *Passenger + Driver* (incl. handbrake lever adapter)

Seat connections | Ford



**Specification: Ford Transit**

Mounting kit: 681-031-00

Drawing: 680-220-00





Aguti Art.No.: 119700 D / 119701 P

Aguti test report: GTÜ R14-18005.00

# A | Fixing kit and assembly tools

## Fixing kit *Passenger*

### A | Material requirements

Fig.	Pcs. (D)	Size	Description
	1×/4 ×	M8x16	Lens head screw (8.8/10.9)
	4 ×	M8x25	Lens head screw (10.9)
	1×/4 ×	M8	Washer
	1×/1×	M10 / M8	Hex nut (8)
	4 ×	M8	Locking nut

### Scope of delivery for passenger side

1 × fixing angle + fixing kit

- ❶ Torque wrench
- ❷ Hex wrench 5 mm

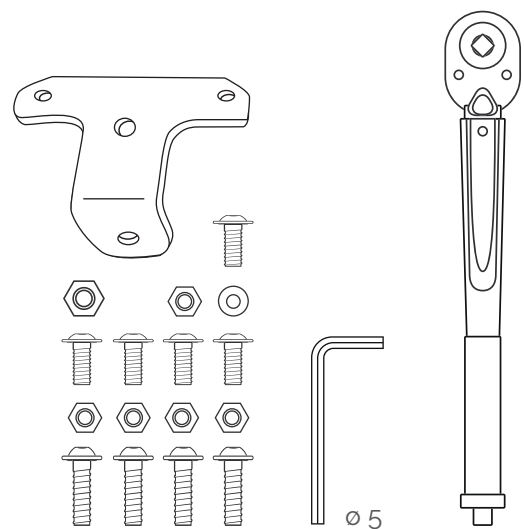

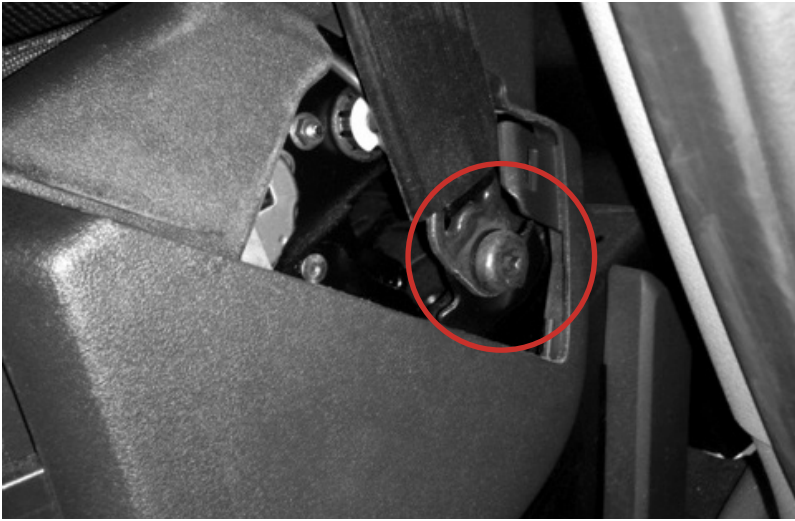

## A | Passenger

### 1 Release the belt fixing point

.....

The belt fixing point will be displaced with the included adapter.

.....



### 2 Remove the seat

.....

Remove the seat according to Ford instructions

.....



### 3 Remove the screws of the seat base

.....

Remove 2 x inner torx stop screws on seat base (will be dropped out).

.....



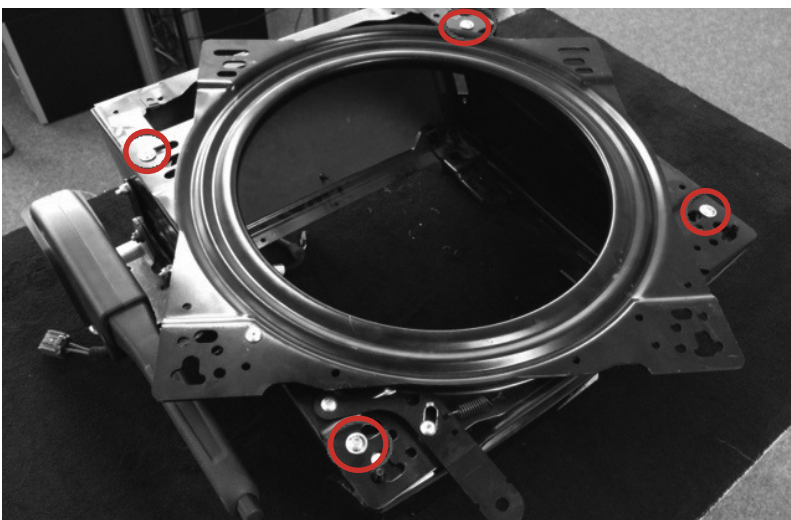
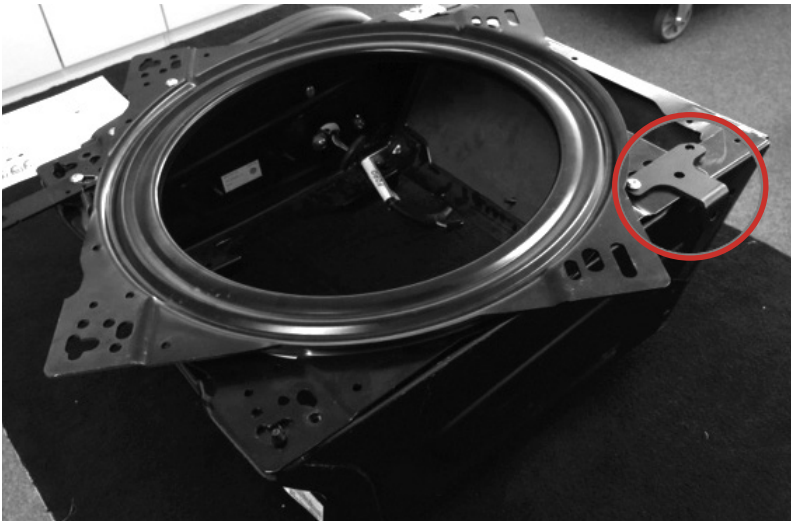

## 4 "Screwing of fixing angle"

Screw the "fixing angle for the belt" to the swivel with  
**1 ×** M8x16 lens head screw,  
**1 ×** washer and **1 ×** nut M8.

**Later more difficult to access**

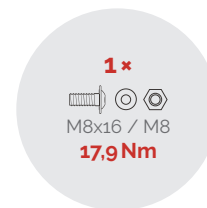

## 5 Swivel on seat base

Screw the swivel onto the seat base with **4 ×** M8x25 screws.

**Put the side with release lever and „fixing angle“ in direction of the vehicle floor. HINT: Release the swivel and turn it into a position easy to assemble.**

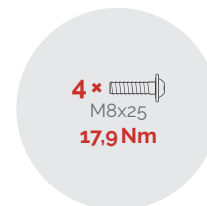



## 6 Screwing of the seat belt

Fix the seat belt with original screws to the new position („fixing angle”) and counter it with the delivered **1 × M10** nut.

**Important: Additionally use liquid screw lock.**

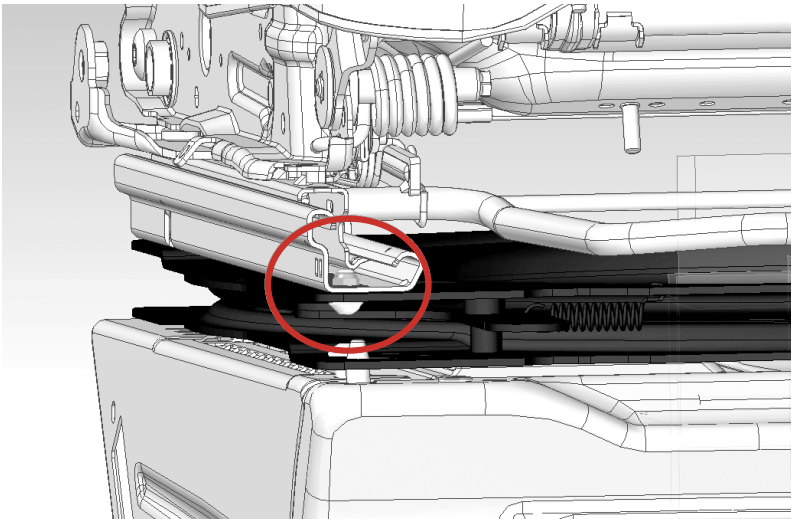

## 7 Original seat on swivel

Screw the original Ford seat onto the swivel with the delivered **4 × M8x16** screws and the **4 × M8** self-locking nuts.

**Pay attention to the right position of the electrical parts and the rotatability of the seat.**

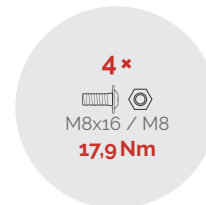

## 8 Connection of the seat electrics









Connection of the seat electrics according to the Ford installation manual.

**Attention: After removal and re-installation of the seat, please check the error memory for eventual malfunction of the seat system!**

# B | Fixing kit and assembly tools

Fixing kit *Driver* (incl. adapter for handbrake)

## B | Material requirements

Fig.	Pcs (D).	Size	Description
	1 × / 4 ×	M8x16	Lens head screw (8.8/10.g)
	4 ×	M8x25	Lens head screw (10.g)
	3 ×	M8x20	Hexagon screw
	1 ×	M8x16	Hexagon screw
	1 × / 4 ×	M8	Washer
	1 ×	24 mm	Large washer
	5 ×	M8	Hex nut (8)
	1 × / 1 ×	M10 / M8	Hex nut (8)
	4 ×	M8	Locking nut

### Scope of delivery

1 × adapter for handbrake  
1 × fixing angle and screw set

- 1 Torque wrench
- 2 Hex wrench 5 mm

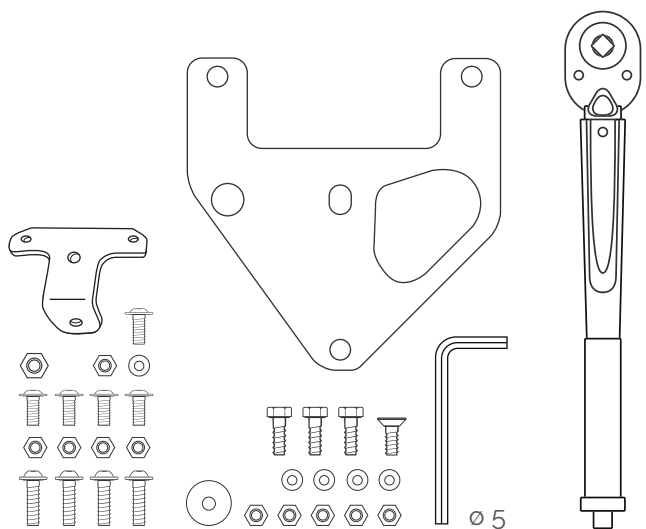



## B | Driver

### 1 Remove the seat

> See instruction passenger  
( Step 1-3).

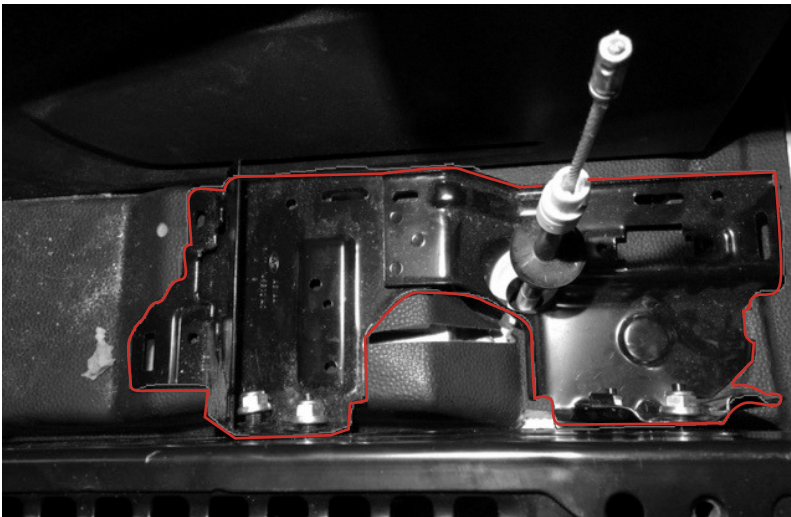

### 2 Remove handbrake

Remove handbrake according  
to Ford instructions

1. Remove Handbrake cover  
(*Not reusable without modifica-  
tion*)
2. Remove coverpanel from the  
floor (*see picture, will be dele-  
ted*)

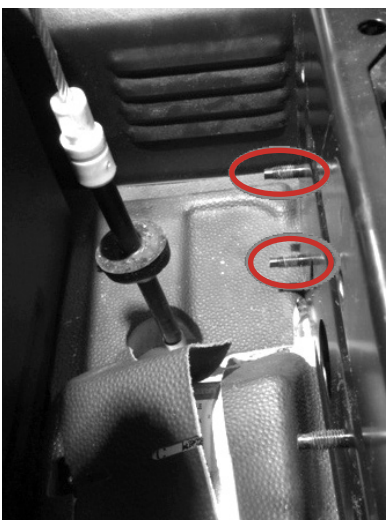

### 3 Remove stud bolt of seat base

Remove two stud bolts of the  
seat base.

**HINT: Remove seat base**

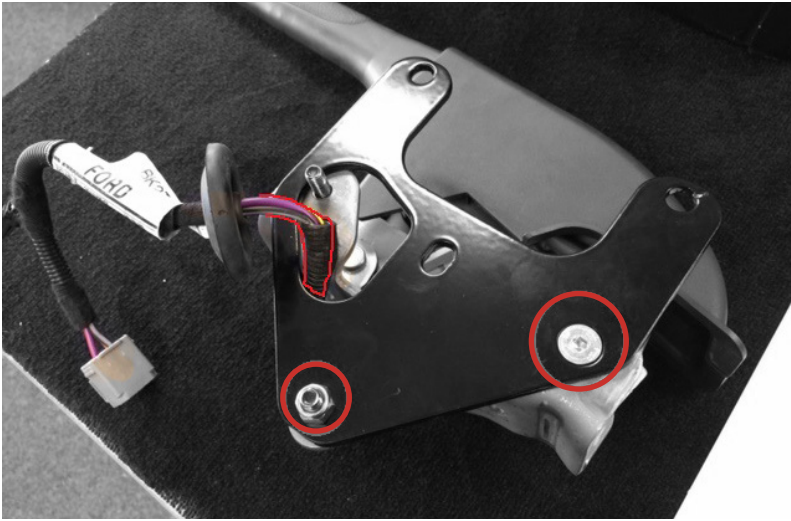

## 4 Installation of adapter

Install the adapter for the handbrake onto the removed handbrake with **1 × M8x16** countersunk screw and **1 × nut**. Pass the cable through.

**1 ×**   
M8x16 / M8  
**17,9 Nm**



## 5 a. Installation of the handbrake with adapter to the seat base

Install the handbrake to the seat base with **3 × M8x20** screws and **3 × nut**

**Pay attention to the right position of the electrical parts!**

**3 ×**   
M8x20 / M8  
**17,9 Nm**



## b. Install washer inside

Install **1 × large washer** and **1 × nut** onto the drilling hole (internal view)

**1 ×**   
24 mm / M8





## 6 Connection and testing of the handbrake

Connection according to Ford instructions.

*The Handbrake is now located deeper to avoid collision with the swivel.*

**Attention: Check the braking effect of the handbrake!**

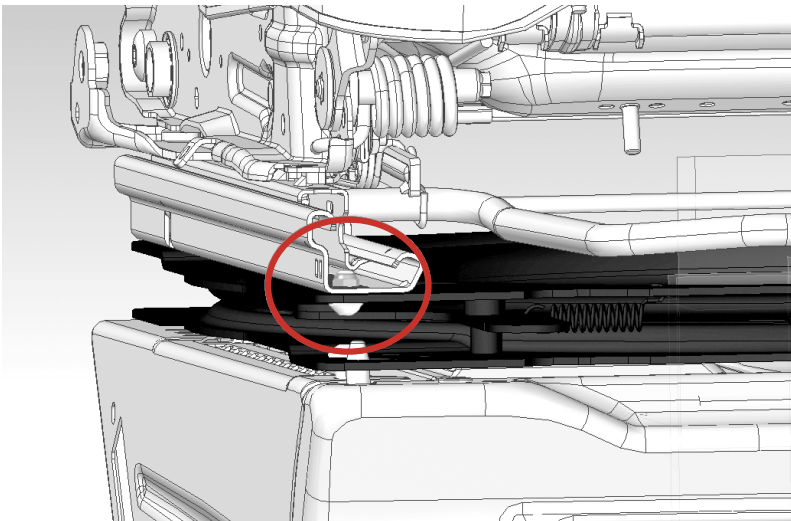

## 7 Installation of swivel and original seat

> See instruction passenger (Step 4-8)

# General information

## Warranty

1. If the buyer is an entrepreneur, we offer a guarantee for defects in the item of either rectification or replacement delivery. However, we are entitled to refuse the type of subsequent performance chosen if this is only possible at an unreasonable cost and if the other type of subsequent performance does not cause a significant disadvantage to the consumer.
2. If the purchaser is a consumer, he or she can first choose whether the subsequent performance will take place by way of rectification or replacement delivery. However, we are entitled to refuse the type of subsequent performance chosen if this is only possible at an unreasonable cost and if the other type of subsequent performance does not cause a significant disadvantage to the consumer.
3. If the type of subsequent performance chosen by the customer is unsuccessful, i.e. if the defect is not rectified or if a fault-free item is not delivered, the customer can fundamentally choose to either lower the compensation (reduction) or have the contract nullified (withdrawal). However, in the event of an insignificant contractual violation, particularly for insignificant defects, where the subsequent performance chosen by the customer is only possible at an unreasonable cost, the customer shall not be entitled to a withdrawal.
4. Entrepreneurs must report obvious defects in writing within the time laid down in section 377 HGB; otherwise the right to assert guarantee claims shall be excluded. If the notification of defect is sent in a timely

manner, the deadline is considered to have been met. The burden of proof falls entirely to the entrepreneur for all claim requirements, particularly for the defect itself, for the date when the defect was discovered and for the timeliness of the defect complaint. Consumers must inform us in writing of any obvious defects, within 2 months of the date when the goods were discovered to be in violation of contractual standards. Compliance with this deadline is based on receipt of the notification by metalfoam. If the consumer fails to provide such notification, the guarantee rights shall lapse 2 months after the defect is discovered. This does not apply in the event of malice on the part of the seller. The consumer shall bear the burden of proof for the date the defect was discovered. If the consumer was persuaded to purchase the item through inaccurate claims by the manufacturer, the consumer shall bear the burden of proof for its purchasing decision. For used goods, the consumer shall bear the burden of proof for the item's defectiveness.

5. If, due to a legal or material defect, the customer chooses to withdraw from the contract, the customer shall not be entitled to any additional damage claims due to the defect. If the customer chooses to claim damages after an unsuccessful subsequent performance, the goods shall remain with the customer if this is reasonable. The damage compensation shall be limited to the difference between the purchase price and the value of the defective item. This shall not apply if we maliciously committed the contractual violation.

6. For entrepreneurs, the guarantee period is 1 year as of the delivery or transfer of the goods. For consumers, the grace period shall be 2 years as of the delivery of the goods. However, this shall not apply if the customer does not notify metalfoam of the defect in a timely manner corresponding to the notification period given in Point 4.

7. If the purchaser is an entrepreneur, only the manufacturer's product description shall determine the agreed characteristics. Public statements, claims or advertisements by the manufacturer do not constitute contractually guaranteed characteristics of the goods.

8. The client does not receive warranties in the legal meaning from us; warranties of the manufacturers will remain unaffected by this.

9. If the customer receives deficient assembly instructions, we shall be merely obligated to supply defect-free assembly instructions and this also only if the defect in the assembly instructions stands in the way of proper assembly.

## § 9 Limitations of liability

1. In the event of slightly negligent violations of obligation, our liability shall be limited to the average direct damages that are foreseeable and typical in contracts for this type of goods. This also applies to slightly negligent violations of obligation by legal representatives, managing employees and other agents. In the event of a slightly negligent violation of insignificant contractual obligations, we shall not be liable to entrepreneurs.

2. The present liability limitations do not apply to the customer's claims arising from product liability. Furthermore, the liability limitations do not apply to attributable damages to body or health, or in the event of the customer's loss of life.

3. The customer's damage claims due to a defect shall lapse one year after the delivery or transfer of the goods. This shall not apply if metalfoam can be accused of malice, or in the event of attributable damages to body or health, or in the event of the customer's loss of life.

Torque table			
	Strength class Nm		
	8.8	10.9	12.9
M4	2.2	3.2	3.8
M5	4.3	6.3	7.3
M6	7.4	10.9	12.7
M8	17.9	26.2	30.7
M10	36.0	53.0	61.0
M12	60.0	90.0	105.0
M14	-	-	-
M16	60.0	-	-
M20	-	-	-
M24	-	-	-
7/16'	40.0		
<b>7/16 screws are to be fixed with medium strength thread locking.</b>			
<b>Deviation of maximum permissible torque</b>			
Screws up to M8	12%+- deviation		
Screws up to M16	10%+- deviation		
Screws up to M24	5%+- deviation		
Screw 7/16	5%+- deviation		